

620

PIPISTRELLO

Design: Gae Aulenti – 1965

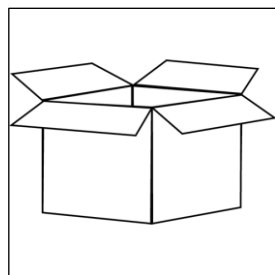

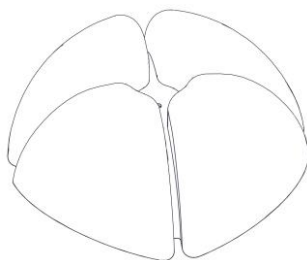
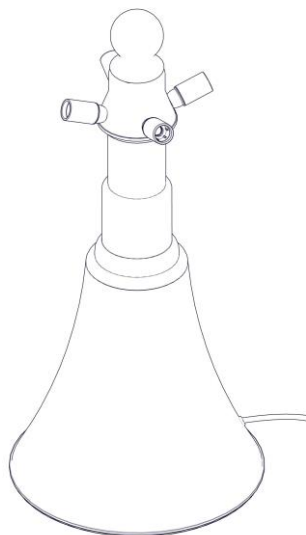
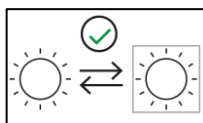
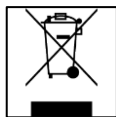
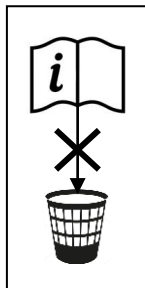
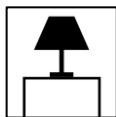

1

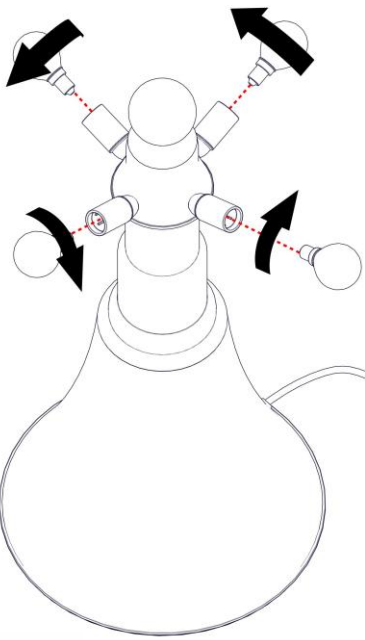

 5 W LED E14

2

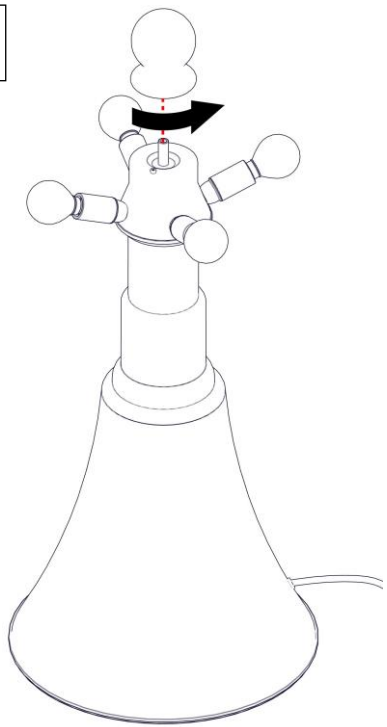

3

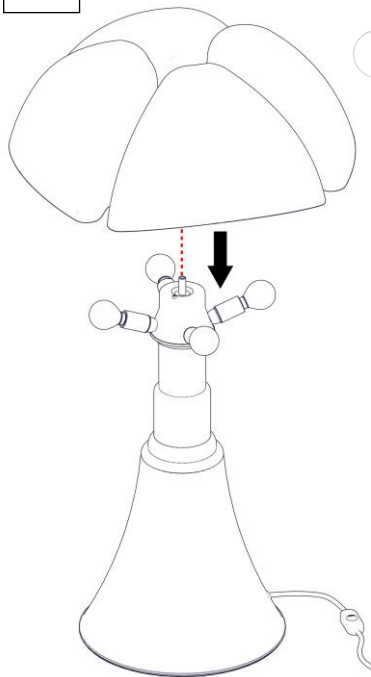

1

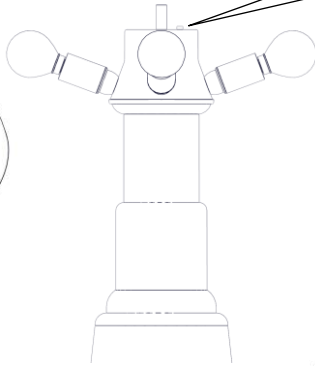

1

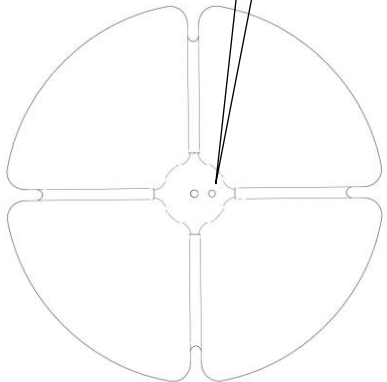

i

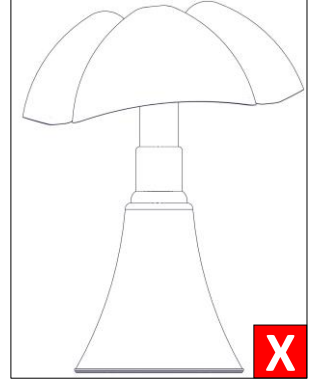
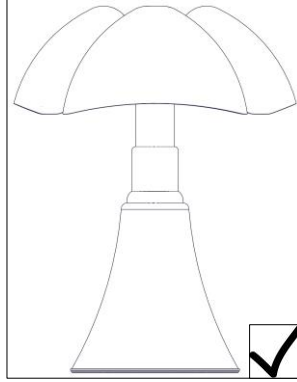
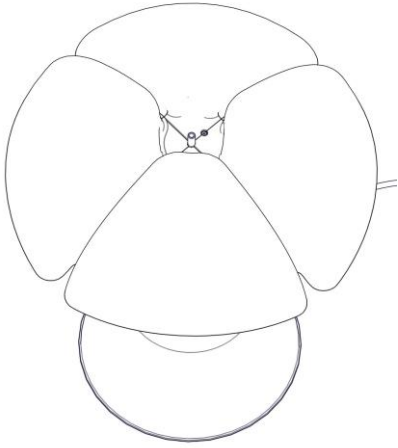

4

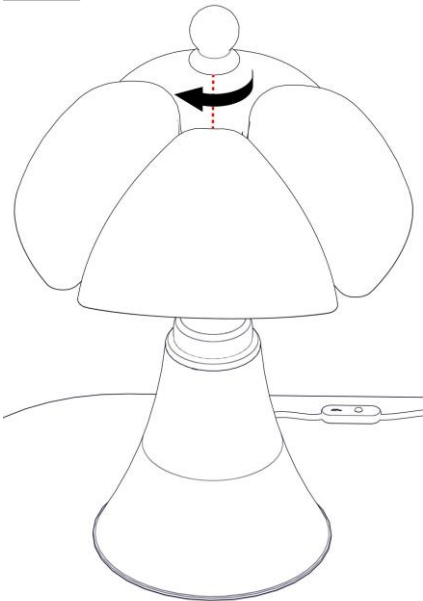

5

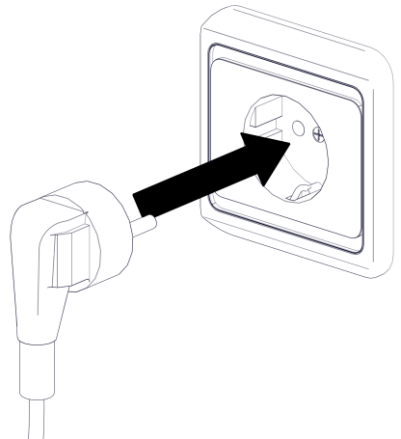

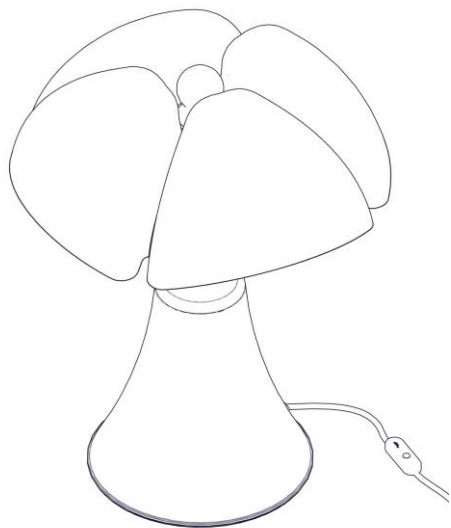

i



i

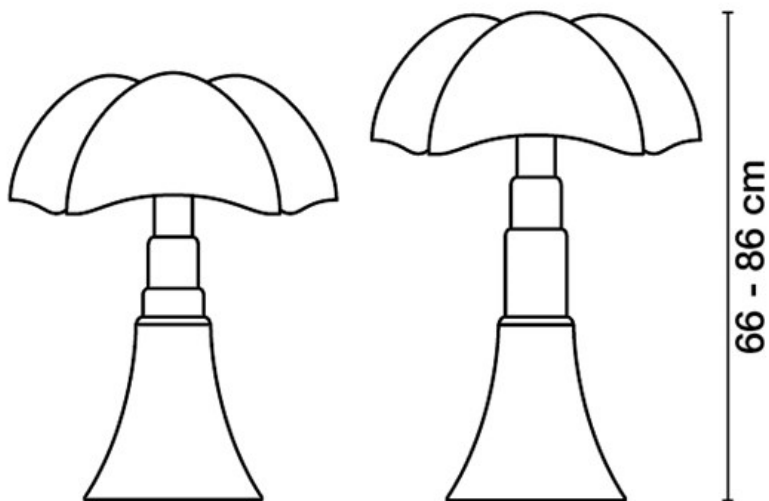



Se il cavo flessibile esterno di questo apparecchio è danneggiato, deve essere sostituito esclusivamente dal fabbricante, dal suo servizio di assistenza o da personale qualificato equivalente, al fine di evitare pericoli.

If the external flexible cord of this appliance is damaged, it should only be replaced by the manufacturer, its service department or equivalent qualified personnel in order to avoid danger

Si le câble flexible externe de cet appareil est endommagé, il doit être remplacé uniquement par le fabricant, son service après-vente ou un personnel qualifié équivalent afin d'éviter tout danger

martinelli luce

Via Teresa Bandettini
55100 Lucca (Lu) – Italy

Tel.+39/0583.418315
Fax. +39/0583.419003

www.martinelliluce.it
info@martinelliluce.it