



Module D'éclairage Ø 120 Cm Lunaop

2700K

Emiliana Martinelli

couleurs disponibles



Type d'appareil Suspension

Utilisation Intérieur

24V 108.5 W 9952 lm



lumière diffuse

Lampe suspension, diamètre 120cm, à lumière diffuse, structure en aluminium peint.
Diffuseur en méthacrylate frost blanc.

Cette lampe est suspendue avec des câbles de suspension/électriques à raccorder sur un rosace à fixer au plafond, pour la version individuelle mais aussi pour la version composée de plus Lunaop. Source de lumière à LED intégrée à 4000K, 3000K ou 2700K.

Rosace à commander séparément disponible dans les accessoires.

Prix





40003/2700

Famille	Module d'éclairage Ø 120 cm Lunaop
Type	Suspension
Utilisation	Intérieur

Dimensions

Hauteur	6,5 cm
Diamètre	120 cm
Longueur du câble d'alimentation	400 cm
Poids	4 Kg

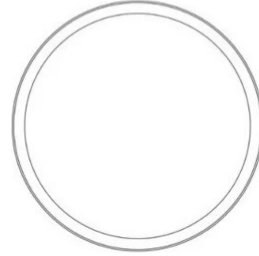
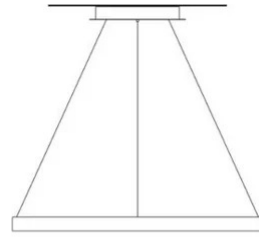

Matériaux

Structure	aluminium	Diffuseur	méthacrylate 040
-----------	-----------	-----------	------------------

Voltage	24V	Watt	108.5 W
Adaptateur d'alimentation	Exclue	Lumen	9952 lm
Montage de l'alimentation	Extérieur	CRI	>80
		CCT	2700 K
		Classe d'énergie	F

Certifications

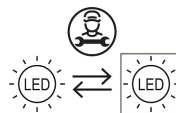



Courbes photométriques

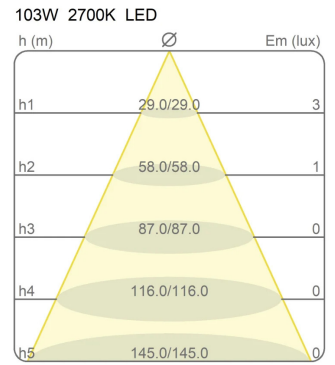
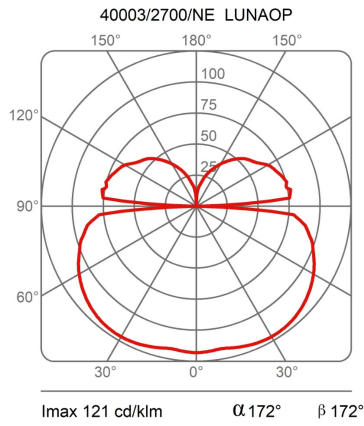
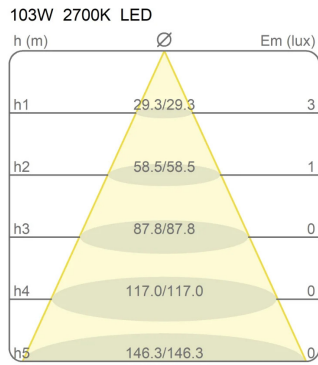
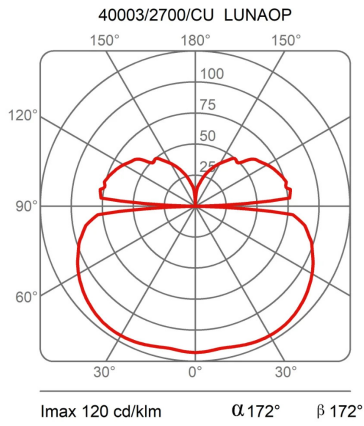
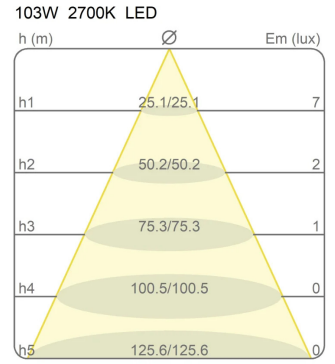
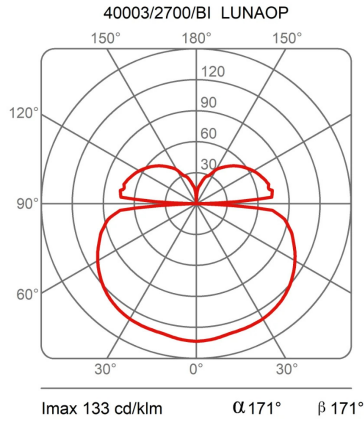
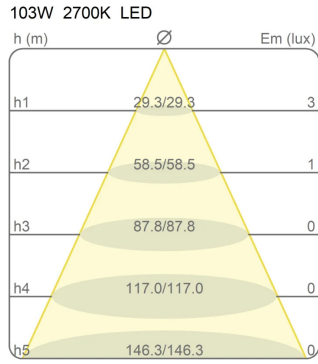
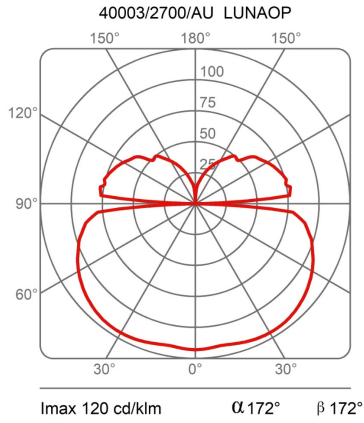

Code de couleur



40003/2700/BI

Blanc



40003/2700/NE

Noir



40003/2700/AU

Or Perlé

40003/2700/BM

Bronze
Texturé

40003/2700/OV

Laiton
Vintage