

2234 / L / 1

V.D.L.

Design: Richard Neutra

martinelli luce®

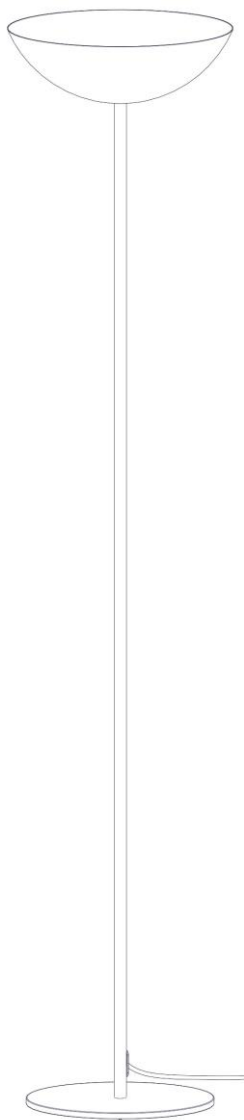

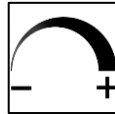
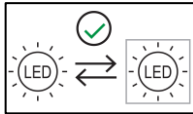
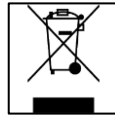
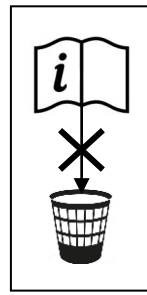
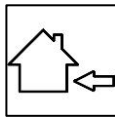

Questo prodotto contiene una sorgente luminosa di classe d'efficienza energetica **F**
This product contains a light source of energy efficiency class **F**
Ce produit contient une source lumineuse de classe d'efficacité énergétique **F**
Este producto contiene una fuente de luz de clase de eficiencia energética **F**
Dieses Produkt enthält eine Lichtquelle der Energieeffizienzklasse **F**
Dit product bevat een lichtbron met energie-efficiëntieklasse **F**

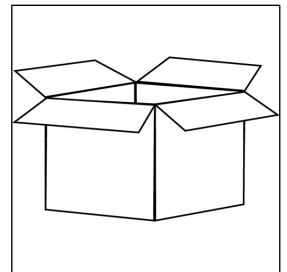
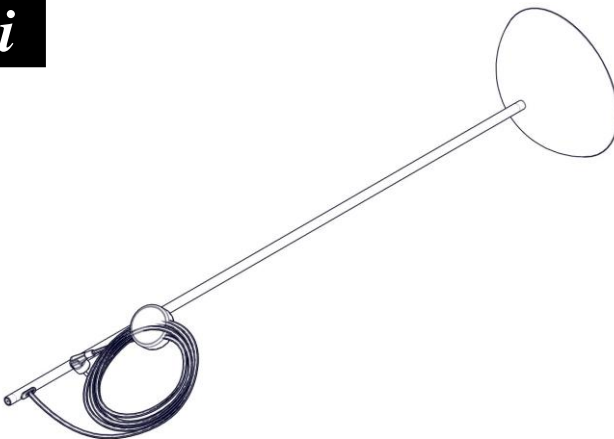

1

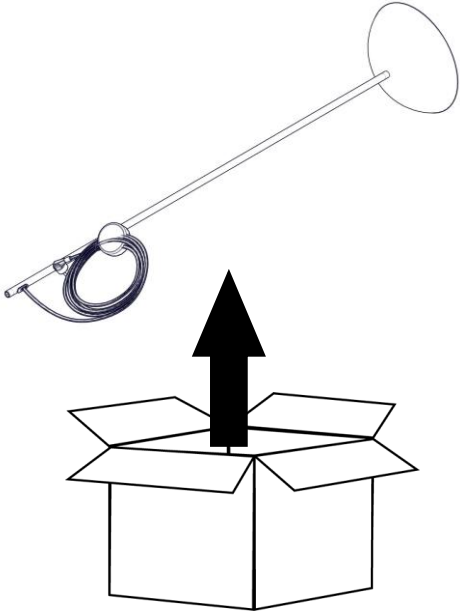

2

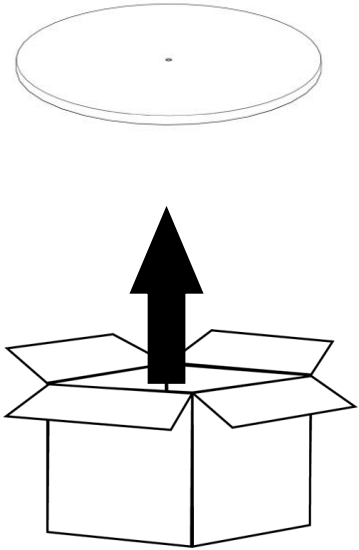

3

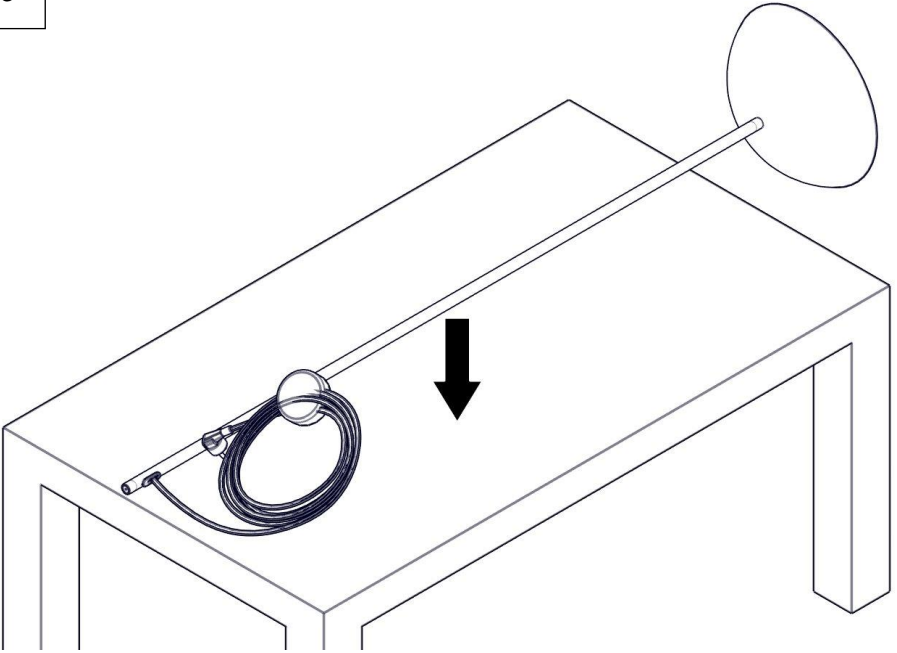

4

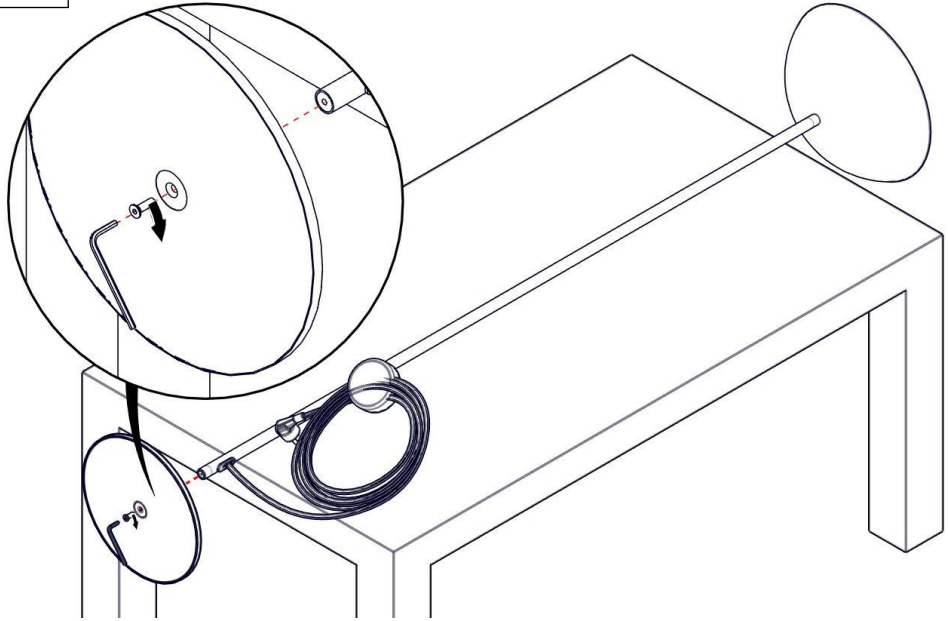

5

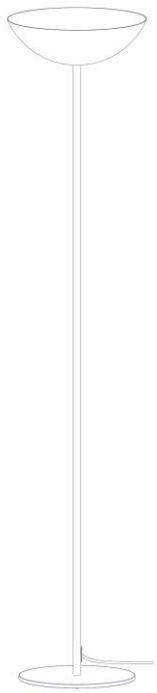
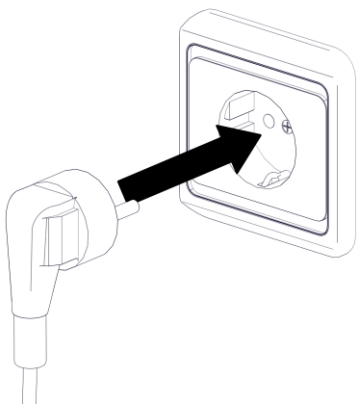

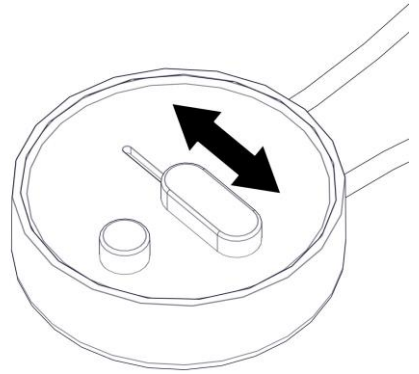
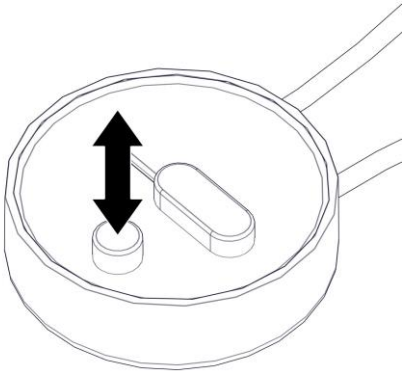

i

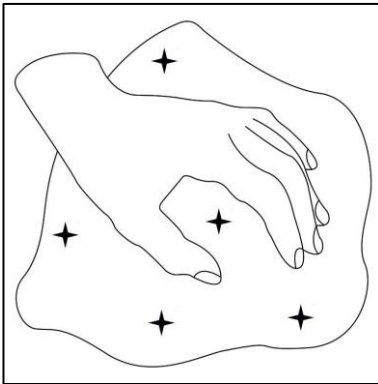

martinelli luce

Via Teresa Bandettini
55100 Lucca (Lu) – Italy

Tel.+39/0583.418315
Fax. +39/0583.419003

www.martinelliluce.it
info@martinelliluce.it